

//DIHR
we mean clean

INDEX

UNDER-COUNTER DISHWASHERS

CS	Robust and essential glass & dishwashers	1
GS	Glass & dishwashers with double-wall door	2
DS	Double skin glass & dishwashers	3
ELECTRON	High-tech double skin glass & dishwashers	4
OPTIMA	Connected glass and dishwashers with clean water technology	5

HOOD-TYPE DISHWASHERS

HT 10	Robust and essential hood-type dishwashers	6
HT 11	Single skin hood-type dishwashers	7
HT 11 I	Insulated hood-type dishwashers	7
HT 12 ELECTRON	Last generation hood-type dishwashers	8
HT 14 OPTIMA	Connected hood-type dishwashers with clean water technology	9



STOCK & WASH DISHWASHERS

TWIN STAR	Stock & Wash Dishwashers	10
-----------	--------------------------	----

RACK-TYPE DISHWASHERS

RX COMPACT	Compact rack-type dishwashers with simple rinse	11
RX EVO	Rack-type dishwashers with single or double rinse	12
RX PRO	Rack-type dishwashers with reinforced double rinse	13
RX OPTIMA	Rack-type dishwashers with 3R+ reinforced triple rinse	14

FLIGHT-TYPE DISHWASHERS

 QX PRO	Flight-type dishwashers with reinforced double rinse	15
 QX OPTIMA	Flight-type dishwashers with 3R+ reinforced triple rinse	16

TRAY WASHER & TRAY TRANSPORTATION SYSTEM

TX Tunnel traywasher with dryer 17

TS Trays transportation systems 17

WAREWASHERS

LP Warewashers 18

GRANULES WAREWASHER

GRANULES Granules warewashers 19

PULL-THROUGH CRATE WASHERS

VX - VX PRO Pull-through crate washers 20

CONVEYOR CRATE WASHERS

LX - LX-HD Conveyor crate washers 21

BASKETS Standard supplied baskets 23

SALES CONDITIONS General sales conditions 24

CS

ROBUST AND ESSENTIAL
GLASS & DISHWASHERS

**SOUND AND HEAT
PROOF DOUBLE-SKIN
DOOR**



**LIGHT WASH AND RINSE
ARMS:** GRANTING THE
BEST EFFICIENCY ALSO
WHEN THE WATER
PRESSURE IS WEAKER







**ELECTRONIC
VERSION AVAILABLE**



**SELF-CLEANING CYCLE
ON THE ELECTRONIC
VERSIONS**



					
	H	Ø	mm	pcs/h	W/D/H mm
CS 35	195	-	350x350	30	400x495x585
CS 40	305	295	400x400	30	450x535x700
CS 40 LS	305	295	400x400	30	450x535x700
CS 50	320	345	500x500	30	590x600x850
CS 35 L	195	-	350x350	38	400x495x595
CS 40 L	305	295	400x400	31	450x535x710
CS 40 LS L	305	295	400x400	31	450x535x710
CS 50 L	320	345	500x500	29	590x600x850

GS

GLASS & DISHWASHERS
WITH DOUBLE-WALL DOOR

UNDER-COUNTER
DISHWASHERS

**SOFT START
WASH PUMP FOR
FRAGILE CROCKERY**
("T" MODELS)



**DISTINGUISH
THEMSELVES BY THEIR
SILENCE AND
FIABILITY**







**ELECTRONIC
VERSION AVAILABLE**



CUSTOMIZABLE



					
	H	Ø	mm	pcs/h	W/D/H mm
GS 35	195	-	350x350	30	400x495x585
GS 37	275	-	370x370	30	420x490x650
GS 37 LS	275	280	370x370	30	420x490x650
GS 40	305	-	400x400	30	450x535x700
GS 40 LS	305	295	400x400	30	450x535x700
GS 50 ECO	320	345	500x500	30	590x600x850
GS 50^U	320	345	500x500	30	590x600x850
GS 40 T	305	-	400x400	60	450x535x700
GS 40 T LS	305	295	400x400	60	450x535x700
GS 50 T	320	345	500x500	60	590x600x850
GS 85 T	355	380	500x500	60	590x600x1290

U: Construction according to UL-NSF standards upon request

DS

DOUBLE SKIN GLASS
& DISHWASHERS

**SOFT START
WASH PUMP FOR
FRAGILE CROCKERY**
("T" MODELS)



**DISTINGUISH
THEMSELVES BY THEIR
SILENCE AND
FIABILITY**



**ELECTROMECHANICAL
VERSION AVAILABLE**







CUSTOMIZABLE



S/S WASH ARMS
(DS 50 - DS 50 T)



					
	H	Ø	mm	pcs/h	W/D/H mm
DS 40	305	295	400x400	30	460x545x715
DS 50^U	310	325	500x500	30	595x610x845
DS 40 T	305	295	400x400	60	460x545x715
DS 50 T	310	325	500x500	60	595x610x845

U: Construction according to UL-NSF standards upon request

ELECTRON

HIGH-TECH DOUBLE SKIN
GLASS DISHWASHERS
& BOTTLE WASHER

UNDER-COUNTER
DISHWASHERS

PLUS SYSTEM



PROGRAMMABLE CYCLES



CONNECTIVITY

WHEREVER YOU ARE...
YOUR DISHWASHER,
JUST A CLICK AWAY



SOFT START

WASH PUMP FOR
FRAGILE CROCKERY









DOUBLE SKIN AISI 304
MACHINE AND
DOUBLE SKIN
INSULATED DOOR



BOTTLE WASHER



						
	H	Ø	mm	pcs/h	tray*	W/D/H mm
ELECTRON 400	310	310	400x400	60	-	460x550x780
ELECTRON 500	325	340	500x500	60	GN 1/1	600x610x850
ELECTRON 500 H+	325	340	500x500	43	GN 1/1	600x610x850
ELECTRON 600	400	400	500x500	53	600x400x25 GN 1/1	600x680x850
ELECTRON 400 PLUS	310	310	400x400	60	-	460x550x780
ELECTRON 400 HR PLUS	310	310	400x400	28	-	460x550x780
ELECTRON 500 PLUS H+	325	340	500x500	60	GN 1/1	600x610x850
ELECTRON 500 HR PLUS H+	325	340	500x500	34	GN 1/1	600x610x850
ELECTRON 1000 PLUS	440	450	500x500	60	600x400x25 GN 1/1	600x700x1380

		H	Ø bottle neck	Ø max bottle	pcs/h	W/D/H mm
BOTTLE COMBI ELECTRON PLUS		325	<16 mm	113 mm	45	600x610x850
BOTTLE COMBI ELECTRON HR PLUS		325	<16 mm	113 mm	19	600x610x850

* Max depth 25 mm with special basket to be ordered

OPTIMA

CONNECTED GLASS AND DISHWASHERS
WITH CLEAN WATER TECHNOLOGY

PLUS SYSTEM:
STABILIZED RINSE,
GUARANTEED
TEMPERATURES,
CONSUMPTION AND
PRESSURE



CONNECTIVITY
WHEREVER YOU ARE...
YOUR DISHWASHER,
JUST A CLICK AWAY







HYGIENE+
HIGH SANITIZATION
LEVELS $A_0=60$



**HEAT
RECOVERY HR:**
IMMEDIATE SAVINGS



**CLEAN WATER
SYSTEM**

						
	H	Ø	mm	pcs/h	tray*	W/D/H mm
OPTIMA 400	310	310	400x400	43	-	460x550x780
OPTIMA 400 HR	310	310	400x400	21	-	460x550x780
OPTIMA 500 SMALL	260	260	500x500	60	-	600x610x730
OPTIMA 500 SMALL HR	260	260	500x500	28	-	600x610x730
OPTIMA 500	340	340	500x500	60	GN 1/1	600x610x850
OPTIMA 500 HR	340	340	500x500	28	GN 1/1	600x610x850
OPTIMA 500 H+	340	340	500x500	60	GN 1/1	600x610x850
OPTIMA 500 HR H+	340	340	500x500	28	GN 1/1	600x610x850

* Max depth 25 mm with special basket to be ordered

HT 10

ROBUST AND ESSENTIAL
HOOD-TYPE DISHWASHERS

**ELECTROMECHANICAL
AND ELECTRONIC
VERSIONS AVAILABLE**



**INNOVATIVE SYSTEM:
COUPLED WASH AND
RINSE ARMS IN
POLYPROPYLENE AND
FIBER OF GLASS**







**SELF-CLEANING CYCLE
ON THE ELECTRONIC
VERSIONS**



**LINEAR OR CORNER
LAYOUTS**

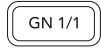

						
	H	Ø	mm	pcs/h	tray*	W/D/H mm
HT 10	355	410	500x500	40	GN 1/1	720x735x1445/1880
HT 10 L	355	410	500x500	46	GN 1/1	720x735x1445/1880

* Max depth 25 mm with special basket to be ordered

HT 11 (I)

SINGLE AND DOUBLE SKIN
HOOD-TYPE DISHWASHERS

**ELECTROMECHANICAL
AND ELECTRONIC
VERSIONS AVAILABLE**



INSULATED HOOD



**LIGHT RINSE ARMS:
EFFICIENT EVEN
WITH LOW PRESSURE
OF THE WATER
INLET**



∅



mm

pcs/h



tray*



W/D/H mm

HT 11 ECO

410

500x500

46

GN 1/1

720x735x1445/1880

HT 11^U

410

500x500

70

GN 1/1

720x735x1445/1880

HT 11 ECO T

410

500x500

72

GN 1/1

720x735x1445/1880

HT 11 T

410

500x500

72

GN 1/1

720x735x1445/1880

HT 11 I

410

500x500

70

GN 1/1

720x735x1445/1880

HT 11 I T

410

500x500

72

GN 1/1

720x735x1445/1880

U: Construction according to UL-NSF standards upon request

* Max depth 25 mm with special basket to be ordered

HT 12 ELECTRON

LATEST GENERATION
HOOD-TYPE DISHWASHERS

HOOD-TYPE
DISHWASHERS



**PROGRAMMABLE
CYCLES**



CONNECTIVITY

WHEREVER YOU ARE...
YOUR DISHWASHER,
JUST A CLICK AWAY



NEW MODEL

MAXXI MULTI-USE
WITH LARGE 600X500
CM BASKET







LIFT:
OF THE HOOD AT THE
END OF THE CYCLE



**HEAT
RECOVERY HR:**
IMMEDIATE SAVINGS



				
	Ø	mm pcs/h	tray*	W/D/H mm
HT 12 ELECTRON	410	500x500 60	GN 1/1	720x735x1445/1880
HT 12 ELECTRON H+	410	500x500 60	GN 1/1	720x735x1445/1880
HT 12 ELECTRON LIFT	410	500x500 60	GN 1/1	720x735x1445/1880
HT 12 ELECTRON LIFT H+	410	500x500 60	GN 1/1	720x735x1445/1880
HT 12 ELECTRON PLUS H+	410	500x500 72	GN 1/1	720x735x1445/1880
HT 12 ELECTRON HR PLUS H+	410	500x500 55	GN 1/1	720x735x1445/1880
HT 12 ELECTRON PLUS LIFT H+	410	500x500 72	GN 1/1	720x735x1445/1880
HT 12 ELECTRON HR PLUS LIFT H+	410	500x500 55	GN 1/1	720x735x1445/1880
HT 12 MAXXI PLUS H+	310	600x500 72	GN 1/1	800x735x1490/1961
HT 12 MAXXI HR PLUS H+	310	600x500 55	GN 1/1	800x735x2162
HT 12 MAXXI PLUS LIFT H+	310	600x500 72	GN 1/1	800x735x1490/1961
HT 12 MAXXI HR PLUS LIFT H+	310	600x500 55	GN 1/1	800x735x2162

* Max depth 25 mm with special basket to be ordered

HT 14 OPTIMA

CONNECTED HOOD-TYPE
DISHWASHERS WITH
CLEAN WATER TECHNOLOGY



PLUS SYSTEM:
STABILIZED RINSE,
GUARANTEED
TEMPERATURES,
CONSUMPTION AND
PRESSURE



CONNECTIVITY
WHEREVER YOU ARE...
YOUR DISHWASHER,
JUST A CLICK AWAY



**CLEAN WATER
SYSTEM**

HYGIENE+
HIGH SANITIZATION
LEVELS $A_0=60$



**HEAT
RECOVERY HR:**
IMMEDIATE SAVINGS



NEW:
AUTOMATIC TWO-STEP
HOOD LIFT



Ø



mm

pcs/h



tray*



W/D/H mm

	Ø	mm	pcs/h	tray*	W/D/H mm
HT 14 OPTIMA	410	500x500	55	GN 1/1	720x735x1445/1880
HT 14 OPTIMA HR	410	500x500	40	GN 1/1	720x735x2095
HT 14 OPTIMA LIFT	410	500x500	55	GN 1/1	720x735x1445/1880
HT 14 OPTIMA HR LIFT	410	500x500	40	GN 1/1	720x735x2095
HT 14 OPTIMA H+	410	500x500	55	GN 1/1	720x735x1445/1880
HT 14 OPTIMA HR H+	410	500x500	40	GN 1/1	720x735x2095
HT 14 OPTIMA LIFT H+	410	500x500	55	GN 1/1	720x735x1445/1880
HT 14 OPTIMA HR LIFT H+	410	500x500	40	GN 1/1	720x735x2095

* Max depth 25 mm

TWIN STAR

STOCK & WASH
DISHWASHERS

STOCK & WASH
DISHWASHERS



-46%
WATER
CONSUMPTION



-38%
ELECTRIC
CONSUMPTION



-82%
DETERGENT
CONSUMPTION



-90%
LABOUR



	Economy	Standard	Intensive	Thermo- disinf.	Deter- gent	Rinse- aid	 W/D/H mm
	59 ℓ	66 ℓ	84 ℓ	94 ℓ			
TWIN STAR	106 min	115 min	127 min	156 min	36 g	3 g	1315x747x2043
TWIN STAR HI TEMP	123 min	132 min	151 min	180 min	36 g	3 g	1315x747x2043
TWIN STAR DOUBLE FACE	106 min	115 min	127 min	156 min	36 g	3 g	1315x810x2043
TWIN STAR DOUBLE FACE HI TEMP	123 min	132 min	151 min	180 min	36 g	3 g	1315x810x2043

Estimated crockery and kitchenware amounts for 20/25 covers							
	120	60	80	20	15	24	23

TWIN STAR: With water softener water supply max 35 °C

TWIN STAR HI TEMP: Without water softener water supply max 65 °C

Max water hardness 5 °f/water hardness > 5 °f external water softener required

RX COMPACT

COMPACT RACK CONVEYOR
DISHWASHERS WITH SIMPLE RINSE

**ELECTROMECHANICAL
AND ELECTRONIC
VERSIONS AVAILABLE**







**5 SPEEDS
(ELECTRONIC VERSION)
3 SPEEDS
(ELECTROMECHANICAL)**



**COMPACT
DIMENSIONS**



						
	Ø	mm	pcs/h	DIN	tray*	W/D/H mm
RX 101	450	500x500	70-100	70	GN 1/1	1080x715x1690/1900
RX 164	450	500x500	100-150	100*	GN 1/1	1880x715x1690/1900
RX 101 E^U	450	500x500	66-100	66	GN 1/1	1080x715x1565/1900
RX 164 E^U	450	500x500	86-150	86	GN 1/1	1880x715x1565/1900

DIN: In compliance with DIN SPEC 10534 regulation

U: Construction according to UL-NSF standards upon request

* Max depth 25 mm

RX EVO

RACK CONVEYOR DISHWASHERS
WITH SINGLE OR DOUBLE RINSE



**ELECTROMECHANICAL
AND ELECTRONIC
VERSIONS AVAILABLE**







**AISI 316 STAINLESS STEEL
TANKS AND BOILERS**



ALL-IN-ONE WASH ARMS



						
	Ø	mm	pcs/h	DIN	tray*	W/D/H mm
RX 104	450	500x500	83-107	83	GN 1/1	1900x805x1830/2120
RX 144	450	500x500	111-143	-	GN 1/1	2100x805x1830/2120
RX 184	450	500x500	148-190	-	GN 1/1	2500x805x1830/2120
RX 184 LC	450	500x500	148-190	-	GN 1/1	2225x985x1830/2120
RX 244	450	500x500	185-238	-	GN 1/1	2800x805x1830/2120
RX 104 E^U	450	500x500	83-107	83	GN 1/1	1900x805x1830/2120
RX 144 E	450	500x500	111-143	92*	GN 1/1	2100x805x1830/2120
RX 184 E	450	500x500	148-190	116*	GN 1/1	2500x805x1830/2120
RX 184 E LC	450	500x500	148-190	-	GN 1/1	2225x985x1830/2120
RX 244 E^U	450	500x500	185-238	134*	GN 1/1	2800x805x1830/2120

DIN: In compliance with DIN SPEC 10534 regulation / U: Construction according to UL-NSF standards upon request
* Max depth 25 mm

RX PRO

RACK CONVEYOR DISHWASHERS
WITH REINFORCED DOUBLE RINSE

CONNECTIVITY

WHEREVER YOU ARE...
YOUR DISHWASHER,
JUST A CLICK AWAY







1-DRAIN

CENTRALIZED DRAIN



AISI 316 **STAINLESS**
STEEL TANKS AND
BOILER



						
	Ø	mm	pcs/h	DIN	tray*	W/D/H mm
RX 246	450	500x500	100-250	100	GN 1/1	2100x805x1830/2120
RX 296	450	500x500	135-300	135	GN 1/1	2700x805x1830/2120
RX 296 LC	450	500x500	135-300	-	GN 1/1	2425x985x1830/2120
RX 326	450	500x500	150-330	150	GN 1/1	3000x805x830/2120
RX 356	450	500x500	190-360	190	GN 1/1	3600x805x1830/2120
RX 356 LC	450	500x500	190-360	-	GN 1/1	3325x985x1830/2120
RX 396	450	500x500	210-400	210	GN 1/1	3900x805x1830/2120





DIN: In compliance with DIN SPEC 10534 regulation
Steam versions available

* Max depth 25 mm

RX OPTIMA

RACK CONVEYOR DISHWASHERS
WITH 3R+ REINFORCED TRIPLE RINSE



						
	Ø	mm	pcs/h	DIN	tray*	W/D/H mm
RX 250	450	500x500	100-250	100	GN 1/1	2250x920x2100/2120
RX 300	450	500x500	135-300	135	GN 1/1	2850x920x2100/2120
RX 300 LC	450	500x500	135-300	-	GN 1/1	2575x985x2100/2120
RX 330	450	500x500	150-330	-	GN 1/1	3150x920x2100/2120
RX 360	450	500x500	190-360	190	GN 1/1	3750x920x2100/2120
RX 360 LC	450	500x500	190-360	-	GN 1/1	3475x985x2100/2120
RX 400	450	500x500	210-400	210	GN 1/1	4050x920x2100/2120

DIN: In compliance with DIN SPEC 10534 regulation

* Max depth 25 mm

QX PRO

FLIGHT CONVEYOR MACHINES
WITH REINFORCED DOUBLE RINSE

**AWARDED FOR THEIR
HIGH EFFICIENCY: LOWEST
CONSUMPTION LEVELS IN
OUR SECTOR**



CONNECTIVITY
WHEREVER YOU ARE... YOUR
DISHWASHER, JUST A CLICK AWAY



1-DRAIN
CENTRALIZED AND
AUTOMATIZED DRAIN



ECO-FRIENDLY
MORE RESPECT FOR
THE ENVIRONMENT



H



pcs/h

DIN



710 mm wide
conveyor



W/D/H mm

	H	pcs/h	DIN	710 mm wide conveyor	W/D/H mm
QX 246	450	1950/3690	2400	710	4500x985x1860/2200
QX 376	450	2400/4050	3300	710	5100x985x1860/2200
QX 416	450	3000/4800	3750	710	5400x985x1860/2200
QX 536^U	450	4200/6450	4650	710	6000x985x1860/2200
QX 596	450	4350/6750	5100	710	6300x985x1860/2200
QX 676	450	5250/8100	6000	710	7300x985x1860/2200
QX 776	450	5850/9000	6450	710	7600x985x1860/2200

DIN: In compliance with DIN SPEC 10534 regulation

Steam versions available

U: Construction according to UL-NSF standards upon request

QX OPTIMA

FLIGHT CONVEYOR MACHINES
WITH 3R+ REINFORCED TRIPLE RINSE

FLIGHT CONVEYOR
MACHINES

**AWARDED FOR THEIR
HIGH EFFICIENCY: LOWEST
CONSUMPTION LEVELS IN
OUR SECTOR**



CONNECTIVITY

WHEREVER YOU ARE... YOUR
DISHWASHER, JUST A CLICK AWAY



SMART DRIVE+ 10 VARIABLE SPEEDS



MULTI PATENTED HDR IMMEDIATE SAVINGS



H



pcs/h

DIN



710 mm wide
conveyor



W/D/H mm

	H	pcs/h	DIN	710 mm wide conveyor	W/D/H mm
QX 250	450	1950/3690	2850	710	5500x1110x2070/2200
QX 380	450	2400/4050	3660	710	6100x1110x2070/2200
QX 420	450	3000/4800	4200	710	6400x1110x2070/2200
QX 540	450	4200/6450	5100	710	7000x1110x2070/2200
QX 600	450	4350/6750	5550	710	7300x1110x2070/2200
QX 680	450	5250/8100	6450	710	8300x1110x2070/2200
QX 780	450	5850/9000	6900	710	8600x1110x2070/2200

TX-TS

TRAY WASHER
& TRAY TRANSPORTATION SYSTEM

HIGH PRODUCTIVITY



HIGH PRESSURE COLD DRYER WITH TURBOBLOWERS



IMMEDIATE REUSE OF THE TRAYS



INTEGRATED HR IMMEDIATE SAVINGS



tray



mm



W/D/H mm

	tray	mm	W/D/H mm
TX			
TX 1600	GN 1/1	-	2575x805x2040/2120
PF	GN 1/1	-	800x500x900

TRANSPORTATION SYSTEM

BCC	GN 1/1	-	upon request
SCT	GN 1/1	-	upon request
SCR	-	500x500	upon request
CCC	-	500x500	upon request



CONNECTIVITY
WHEREVER YOU ARE...YOUR DISHWASHER, JUST A CLICK AWAY













PROGRAMMABLE CYCLES



PLUS SYSTEM:
STABILIZED RINSE, GUARANTEED TEMPERATURES, CONSUMPTION AND PRESSURE



							
	H	Ø	mm	pcs/h	H	tray*	W/D/H mm
LP1 S4	400	400	500x500	53	Euronorm	600x400x25	600x680x850
LP1 S5 PLUS	-	-	500x610	60	440	600x400x25	600x700x1380
LP1 400 PLUS**	-	410	500x600	72	-	600x400x25	720x735x1445/1915
LP1 400 PLUS LIFT**	-	410	500x600	72	-	600x400x25	720x735x1445/1915
LP1 800	-	-	550x665	30	805	600x400x25	650x750x1690/2070
LP1 S8 PLUS**	-	-	550x665	30	805	600x400x25	690x800x1890/2275
LP2 S PLUS**	-	-	700x700	20	645	600x400x25	840x885x1790/2050
LP3 S PLUS**	-	-	850x725	20	645	600x400x25	990x885x1790/2050
LP4 S8 PLUS**	-	-	1350x725	20	820	600x400x25	1490x885x1970/2310

					
	mm	mm	pcs/h	mm	tray* W/D/H mm
LP1 MAXXI PLUS**	500x600	500x600	72	500x600	600x400x25 800x735x1490/1961
LP1 MAXXI PLUS LIFT**	500x600	500x600	72	500x600	600x400x25 800x735x1490/1961

* Max depth 25 mm ** Heat recovery version available

GRANULES

GRANULES
WAREWASHER

MULTI PATENTED



WITH THE **GRANULES**
SOAKING IS NO
LONGER NECESSARY







SIGNIFICANTLY
REDUCES WORKING TIME



LESS WATER AND ENERGY
CONSUMPTION



	 GN 1/1	 GN 2/1			
	pcs	pcs	Ø	H	W/D/H mm
GRANULES 900 PLUS	6	2	735	635	1095x910x1910/2020
GRANULES 900 HR PLUS	6	2	735	635	1095x910x2100
GRANULES 1000 HR PLUS	8	4	850	830	1200x1010x2260/2305

POWERFUL WASH SOLUTIONS

FOR BAKERIES, PASTRIES
AND FOOD INDUSTRY



**ONE-PERSON LOADING
SYSTEM (SPECIAL
VERSIONS)**



**LOW
RUNNING COSTS**

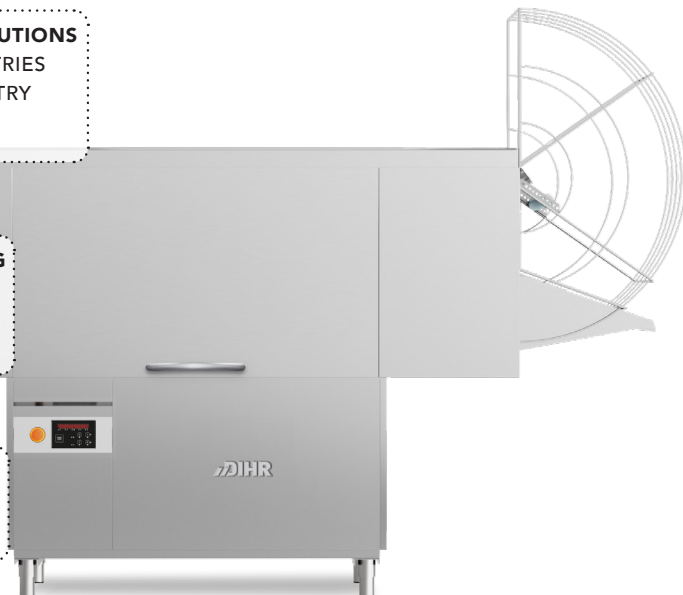

pcs/h



W/D/H



W/D/H



W/D/H mm

	pcs/h	W/D/H	W/D/H	W/D/H mm
VX 231	200	510x600x500	-	2600x805x1830/2120
VX 231 SPECIAL	200	510x600x500	-	2710x805x2075/2120
VX 281	200	510x600x800	-	2800x805x2130/2720
VX 301	260	510x600x500	-	4100x805x1830/2120
VX 301 SPECIAL	260	510x600x500	-	4210x805x2075/2120
VX 401	400	510x600x500	-	4100x805x1830/2120
VX 401 SPECIAL	400	510x600x500	-	4210x805x2075/2120
VX 251 PRO	200	510x600x500	510x600x500	3200x805x1830/2120
VX 351 PRO	260	510x600x500	510x600x500	4700x805x1830/2120

Steam version available for models: VX 231 - VX 301 - VX 401





CONNECTIVITY
WHEREVER YOU ARE... YOUR
DISHWASHER, JUST A CLICK AWAY



**HEAVY
WORKLOADS**



			
	pcs/h	W/D/H	W/D/H mm
LX 501	345	640x600x450	4900x985x1860/2200
LX 751	510	640x600x450	5800x985x1860/2200
LX 1001	695	640x600x450	6700x985x1860/2200
LX 1251	823	640x600x450	7600x985x1860/2200
LX 851 HD	215	640x600x450	6200x985x1860/2200
LX 1101 HD	300	640x600x450	7500x985x1860/2200

Steam version available

STANDARD SUPPLIED BASKET

GLASSWASHERS	2 x glass basket, 1 x saucer holder, 1 x cutlery holder
DISHWASHERS	1 x dish basket, 1 x glass basket, 1 x cutlery holder (Electron 1000 Plus + 1 C43)
HOOD-TYPE DISHWASHERS	2 x dish basket, 1 x glass basket, 2 x cutlery holder 1 x plates basket, 1 x large mesh basket, 1 x tray basket, 2 x cutlery holder (HT 12 MAXXI PLUS)
RACK CONVEYOR DISHWASHERS	1 x dish basket, 1 x glass basket, 1 x cutlery basket 8 places, 1 x tray basket
WAREWASHERS	LP1 S4 - LP1 400 PLUS: 1 x S/S trays support, 1 x large mesh plastic basket, 1 x spatula holder (LP1 S4 + 1 S/S griddle) LP1 S5 PLUS: 1 x S/S basket, 1 x trays support, 1 x S/S spatula holder LP1 MAXXI PLUS: 1 x dish basket, 1 x large mesh basket, 1 x large mesh plastic basket, 1 x tray basket LP1 800 - LP1 S8 PLUS: 1 x S/S basket, 1 x S/S griddle, 1 x trays support, 1 x S/S spatula holder LP2 S PLUS - LP3 S PLUS - LP4 S8 PLUS: 1 x S/S basket, 1 x S/S trays support, 1 x S/S spatula holder

SALES CONDITIONS

DELIVERY	20 days for semi-automatic machines - 50 days for automatic machine
PACKING	Cardboard box (included in the price) The wooden cage's price is the equivalent of the 2% of the machine's net price -minimum amount charged is 85 € (on the following models: RX, QX, TX, TS, VX, LX, LX-HD, TC, RTC, LC77/2, LC77/3, LC96, LC97, LC97/2, LC97/3, A10, A20)
SPARE PARTS	For orders lower than net 50 €, a 5 € fee will be applied as management costs
TERMS	Ex-works
WARRANTY ON OUR PARTS	24 months from invoice date, subject to our technical department verification of the problem causes
TRANSPORT	The supply is carried out Ex works DIHR Ali Group Srl. The goods travel at the Purchaser's sole risk even when the carrier has been chosen and instructed by DIHR Ali Group Srl on behalf of the purchasing party
OWNERSHIP RESERVATION	The goods are the exclusive property of DIHR Ali Group Srl until the invoice is paid in full
COURT OF JURISDICTION	Contracts stipulated with DIHR Ali Group Srl are subject to Italian law. For any dispute that may arise from contracts with DIHR Ali Group Srl - including abroad contracts - the court of jurisdiction shall be that of Treviso
USER MANUALS	User Manuals are originally issued in a main E.U. language. When put into service, each machinery must be provided with an appropriate translation of the original Manual in the language(s) used in the Country where the appliance is installed accompanied by its original instructions, too. This translation is full care and responsibility of the Importer of the machinery in the end-user's region. In case of tunnel machines, the possibility to have our technician/s on site to assist in the assembly and start-up will be quoted separately.



an Ali Group Company



The Spirit of Excellence